



Safety relief valves, type SFV 20 - 25

Contents

	Page
Introduction.....	3
Features.....	3
Technical data.....	4
Design.....	5
Capacity.....	6
Material specification.....	9
Connections.....	10
Dimensions and weights.....	10
Ordering.....	11

Introduction



SFV 20 - 25 are standard, **back pressure dependent** safety relief valves in angle-way execution, specially designed for protection of vessels and other components against excessive pressure.

The valve is designed to meet the strict quality demands and safety requirements for refrigeration installations, specified by the international classification societies.

The valve is recommended as an external and internal safety relief valve in refrigeration plants. The spring housing is closed tightly to avoid refrigerant leakage.

The inlet flow diameters of the valves are:

- 18 mm (³/₄ in.) for SFV 20, and
- 23 mm (1 in.) for SFV 25.

The valves can be delivered with set pressures between 10 and 25 bar g (145 and 363 psi g).

Standard pressure setting valves having "TÜV Pressure Setting Certificate" with each valve, are also available.

Features

- Applicable for the refrigerants R717 (ammonia, NH₃), HFC, HCFC (e.g. R22, R134a, R404A) and other refrigerants (dependent on sealing materials compatibility) within a temperature range of -30°C/+100°C (-22°F/+212°F).
- Classification: To get an updated list of certification on the products please contact your local Danfoss Sales Company.

Technical data

- Refrigerants
Applicable for the refrigerants R717 (ammonia, NH₃), HFC, HCFC (e.g. R22, R134a, R404A) and other refrigerants dependent on sealing material compatibility within a temperature range of -30°C/+100°C (-22°F/+212°F). Flammable hydrocarbons are not recommended. For further information please contact your local Danfoss Sales Company.

- Pressure
Pressure setting range: 10 - 25 bar g (145 - 363 psi g). For further information please contact your local Danfoss Sales Company.

The valves are designed for:
Strength test: 43 bar g (624 psi g)
Leakage safety: Same as set pressure

Important: The SFV safety relief valve is dependent on the back pressure (if the back pressure is higher than the atmospheric pressure, the opening pressure will be higher than stated set pressure).

Special circumstances such as vibrations (which should be avoided) and oscillating pressure may require an increased difference between the operational pressure and the closing pressure.

- Pressure setting
The operating pressure of the plant should be at least 15% below the set pressure. This allows a perfect re-seating of the safety relief valve after having been activated.
- Temperature range
-30/+100°C (-22/+212°F)

Pressure Equipment Directive (PED)
The SFV-valves are approved in accordance with the European standard specified in the Pressure Equipment Directive and are CE marked.
For further details / restrictions - see Installation Instruction



SFV valves		
Nominal bore	18 mm (0.709 in.)	23 mm (0.906 in.)
Classified for	Fluid group I	
Category	IV	

Design

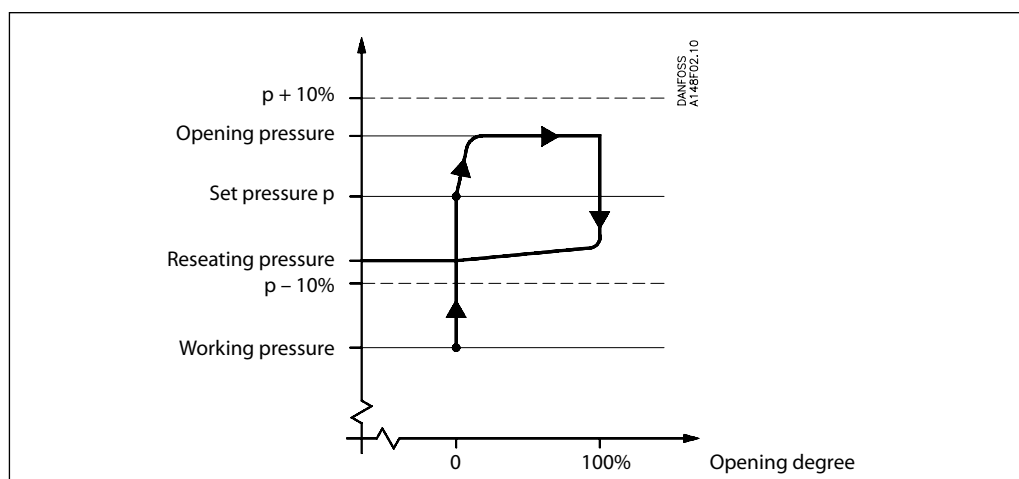

SFV is designed as a **standard safety relief valve** (DIN 3320), which are recommended for refrigeration plants. On a rise in pressure above the set pressure, the safety relief valve will initially start opening slightly, to minimise the outlet of

refrigerant. If the pressure continues to increase, the valve will open fully. The safety relief valve will be fully open before the pressure is 10% higher than set pressure, and fully closed before the pressure is 10% below set pressure.

Connections

Available with the following connections:

- Outside pipe thread T (ISO 228/1)
- Welding fittings (DIN 2448)

Housing

Made of special steel approved for low temperature operation. Spindle and seat are made of stainless steel, to ensure precise operation even during extraordinary conditions. The gasket of the valve cone is made of a special chloroprene (neoprene) compound.

Installation

To ensure exact operation of the safety relief valve it should be installed with the spring housing upwards. If the valve is mounted as an internal safety relief valve without any demand for exact opening pressure, the valve may be fitted with the spring housing in other positions. When the valve is mounted, it is important to avoid the influence of static, dynamic and thermal stress.

A very precise technique has been applied for the production of the seal. However, this seal can still be damaged, if dirt is blown from the pipe system into the valve.

It is recommended that safety relief valves exhaust into the open air with a U-pipe filled with oil on the discharge branch, to prevent dirt from penetrating into the valve. It is also recommended that the valves be installed in pairs in conjunction with the double stop valve type DSV. For further information please see the DSV data sheet.

Re-calibration/servicing

In certain countries the authorities demand that the valves are readjusted at least once a year (see local rules).

Control/Identification

After adjustment of the set pressure at Danfoss, the valves are sealed. For that reason Danfoss can only guarantee correct operation, as long as the seal remains unbroken.

All valves are provided with a metal plate with the following information:

- Flow diameter
- Set pressure
- Date of production
- Production number
- Type approved code.

Transport/Handling

The valves are fitted with special protection covers and packed into purpose made transportation cartons.

It is important the cover remains fitted around the valve until it is installed.

To ensure the exact and precise operation of the valve it must be handled with care.

Capacity

The design and construction of the safety relief valve has been tested and approved by TÜV. This test comprises control of the function of the valve as well as measuring of the capacity, which is the basis of the curves and tables on the following pages. The values in the table are based on saturated gas.

If e.g. back pressure or superheated gas have to be taken into consideration, the formulas or the Danfoss computation program (DIRcalc™) can be used.

Table 1.

Valve	Nominal size		Flow diameter d_o	Flow area A_o	De-rated, certified coefficient of discharge K_{dr}
	Inlet	Outlet			
SFV 20	20 mm	25 mm	18 mm	254 mm ²	0.54
	¾ in.	1 in.	0.709 in.	0.394 in ²	
SFV 25	25 mm	32 mm	23 mm	415 mm ²	0.48
	1 in.	1¼	0.906 in.	0.643 in ²	

The discharge capacity of the safety relief valves are based on (ISO 4126-1 / prEN 1313 6 (1998)).

$$q_m = 0.2883 \times C \times A_o \times K_{dr} \times K_b \sqrt{p}$$

q_m Discharge capacity (kg/h)

C Discharge function depending of the actual refrigerant (κ) see table 2 (-)

A_o Flow area of the safety relief valve (mm²).

K_{dr} De-rated coefficient of discharge ($K_{dr} = K_d \times 0.9$), (the K_{dr} is certified by TÜV) see table 1 (-)

K_b Correction factor for sub-critical flow. (-)

$K_b = 1.0$ when the back pressure is lower than approx. $0.5 \times$ relieving pressure ($P_b < 0.5 \times p$)

For all SFV safety valves $K_b = 1.0$

v Specific volume of the vapour at the relieving pressure p . (m³/kg)

p_{set} Set pressure, the predetermined pressure at which a pressure relief valve under operation starts to open (p_{set} is indicated on the metal plate on the safety relief valve).
(bar gauge)

p_{atm} Atmospheric pressure. (1 bar)

p Relieving pressure, $p = p_{set} \times 1.1 + P_{atm}$ (bar absolute)

For further details see the above-mentioned ISO or EN standards.

Table 2. Properties of Refrigerants

Refrigerant	Isentropic exponent κ	Discharge function C
R22	1.17	2.54
R134a	1.12	2.50
R404A	1.12	2.49
R410A	1.17	2.54
R717 (Ammonia)	1.31	2.64
R744 (CO ₂)	1.30	2.63
Air	1.40	2.70

Capacity
(cont.)

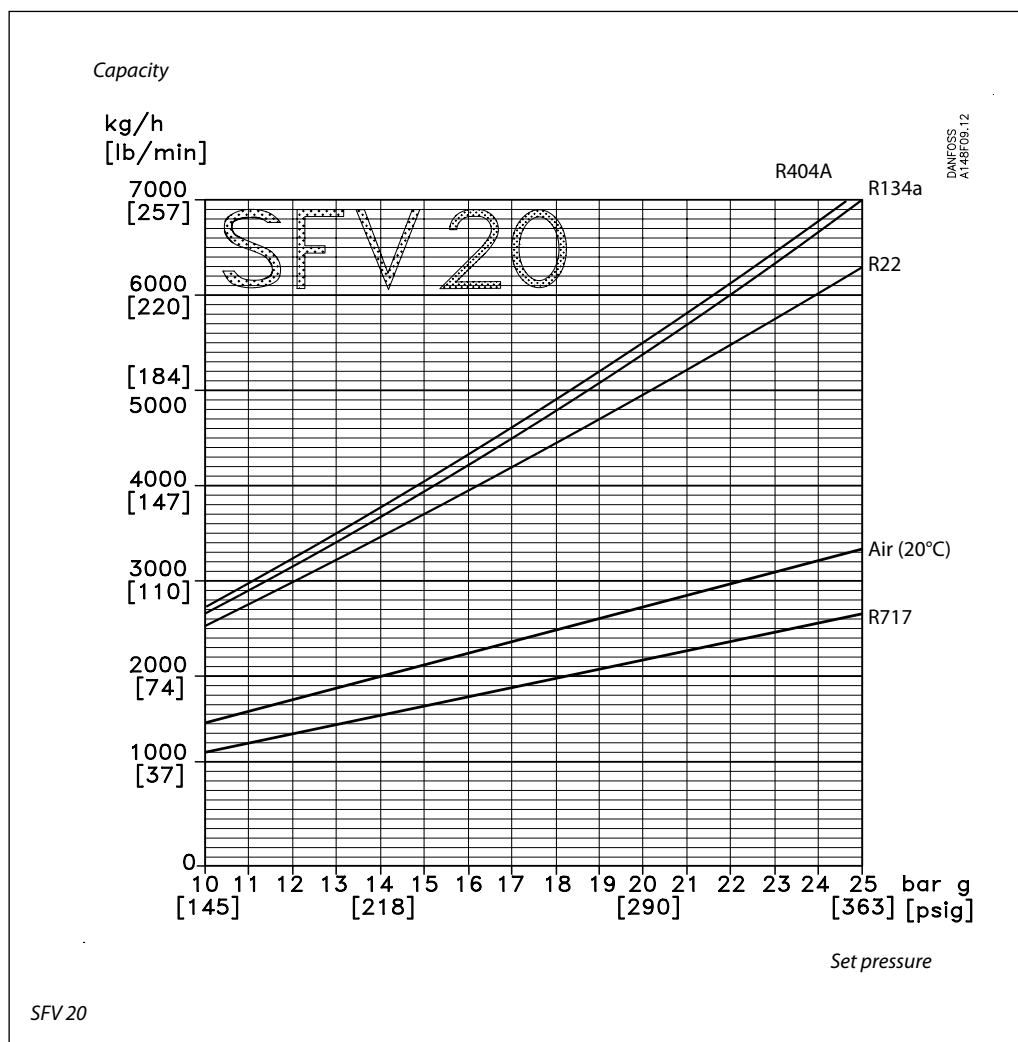

Capacity

Set pressure		R22	R134a	R404A	R717	Air (20°C)
SFV 20						
13 bar g	kg/h	3220	3430	3500	1415	1790
189 psi g	lb/min	118	126	129	52	66
18 bar g	kg/h	4440	4800	4900	1925	2435
261 psi g	lb/min	163	176	180	71	89
21 bar g	kg/h	5215	5680	5770	2235	2820
305 psi g	lb/min	192	209	212	82	104
25 bar g	kg/h	6285	6980	7125	2660	3335
363 psi g	lb/min	231	257	262	98	122

Capacity
(cont.)

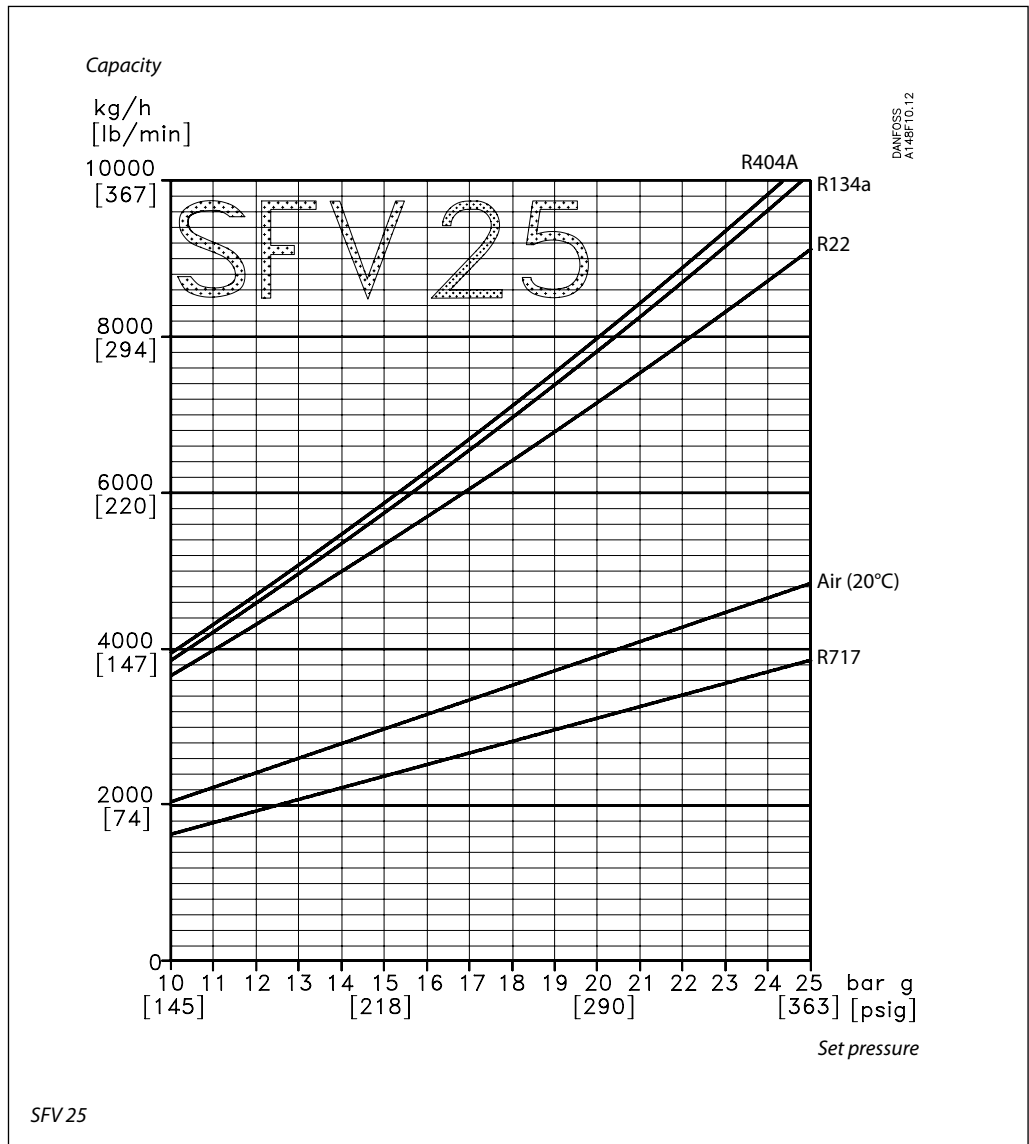

Capacity

Set pressure		R22	R134a	R404A	R717	Air (20°C)
SFV 25						
13 bar g	kg/h	4670	4980	5075	2050	2600
189 psi g	lb/min	172	183	186	75	96
18 bar g	kg/h	6445	6965	7115	2790	3530
261 psi g	lb/min	237	256	261	103	130
21 bar g	kg/h	7565	8240	8370	3240	4090
305 psi g	lb/min	278	303	308	119	150
25 bar g	kg/h	9120	10135	10340	3860	4835
363 psi g	lb/min	335	372	380	142	178

Material specification

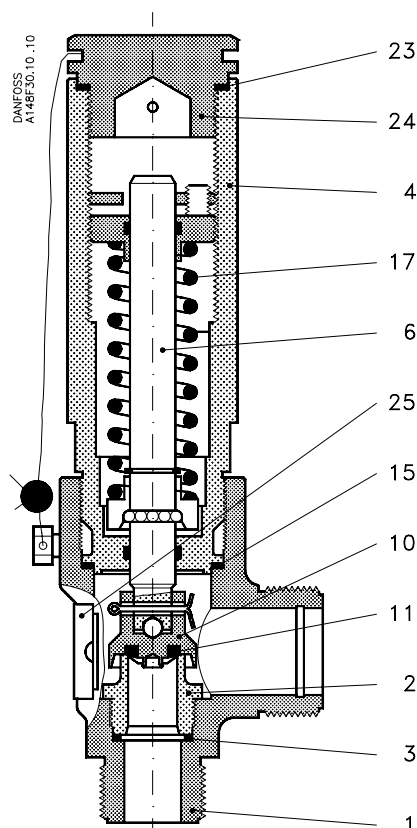

No.	Part	Material	DIN	ISO	ASTM
1	Housing	Steel	TT St 35 N, 17173	TW 6, 2604/3-75	Grade 1, A333, A334 * A350 LF2
2	Valve seat	Stainless steel	X10CrNiS189, 17440	Type 17, 683/13	AISI 303
3	Packing washer	Aluminium *Non-asbestos gasket			
4	Valve top	Steel	St. 37.2, 1652	Fe 360 B, 660	Grade C, A 283
6	Valve spindle	Stainless steel	X10CrNiS189, 17440	Type 17, 683/13	AISI 303
10	Valve cone	Steel			
11	Valve cone seal	Cloroprene (Neoprene)			
15	Packing washer	Aluminium *Non-asbestos gasket			
17	Spring	Steel	Class C	A 679, 17223	
23	Packing washer	Aluminium *Non-asbestos gasket			
24	Plug	Steel	9S Mn28, 1651 *R St 37.2, 17100	Type 2, R 683 Fe 360 B, 630	Grade C, A 283
25	Marking label	Aluminium			

* Alternative material

Connections

T

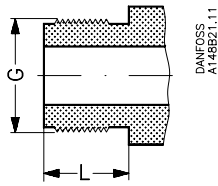

Size mm	Size in.	Inlet	Outlet	L mm	L in.
---------	----------	-------	--------	------	-------

T outside pipe thread, (ISO 228/1)

20	3/4	G 1 1/4	G 1 1/2	20	0.79
25	1	G 1 1/4	G 1 1/2	20	0.79

DIN

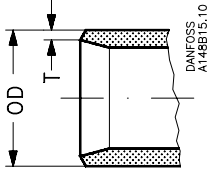

Size mm	Size in.	Inlet (mm)		Inlet (in.)		Outlet (mm)		Outlet (in.)	
		OD	T	OD	T	OD	T	OD	T

Welding fittings DIN (2448)

20	3/4	26.9	2.3	1.059	0.091	33.7	2.6	1.337	0.102
25	1	33.7	2.6	1.327	0.102	42.4	2.6	1.669	0.102

Dimensions and weights

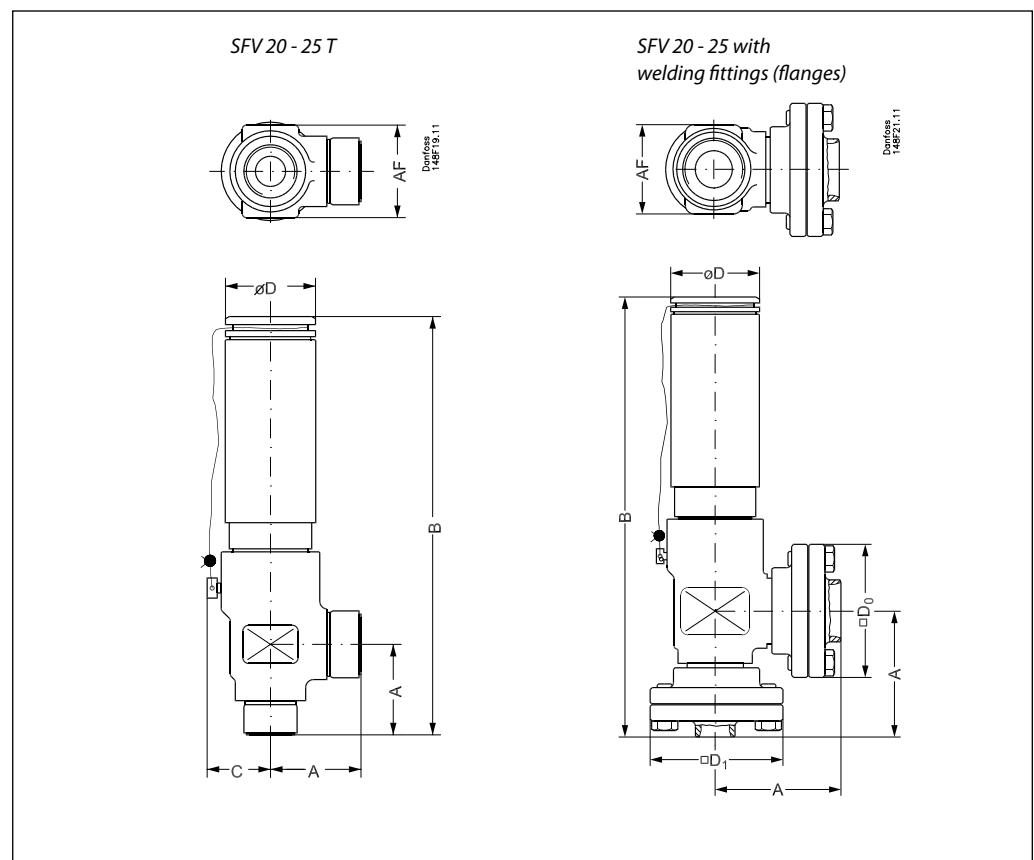

Valve size	A	B	C	□ D ₀	øD	□ D ₁	AF	Weight
------------	---	---	---	------------------	----	------------------	----	--------

SFV 20 - 25 T, with threaded connections ISO 228/1 pipe threads

SFV 20 (3/4 in.)	mm in.	55 2.17	270 10.63	40 1.57	60 2.36	60 2.36	4.2 kg
SFV 25 (1 in.)	mm in.	55 2.17	270 10.63	40 1.57	60 2.36	60 2.36	4.2 kg

SFV with welding fittings, DIN 2448

SFV 20 (3/4 in.)	mm in.	85 3.35	300 11.81	90 3.54	60 2.36	90 3.54	60 2.36	6.0 kg
SFV 25 (1 in.)	mm in.	85 3.35	300 11.81	90 3.54	60 2.36	90 3.54	60 2.36	6.0 kg

Specified weights are approximate values only.

Ordering
How to order

The table below is used to identify the valve required.

Please note that the type codes only serve to identify the valves, some of which may not form part of the standard product range. For further information please contact your local Danfoss Sales Company.

Example for type codes

SFV 20 T 210

Type codes

Valve type	SFV	Safety relief valve																																																																																																							
Nominal size in mm (valve size measured on the connection diameter)	20 25	<table border="1"> <thead> <tr> <th colspan="2">Available connections</th> </tr> <tr> <th>T</th> <th>DIN welding fitting</th> </tr> </thead> <tbody> <tr> <td>DN 20</td> <td>x</td> </tr> <tr> <td>DN 25</td> <td>x</td> </tr> </tbody> </table>		Available connections		T	DIN welding fitting	DN 20	x	DN 25	x																																																																																														
Available connections																																																																																																									
T	DIN welding fitting																																																																																																								
DN 20	x																																																																																																								
DN 25	x																																																																																																								
Connections	T	Outside threaded connections: ISO 228/1 Pipe thread - The welding fittings for single mounted safety relief valve must be ordered separately																																																																																																							
Pressure setting		<i>Standard pressure setting: 2××</i> <table border="1"> <thead> <tr> <th></th> <th>SFV 20</th> <th>SFV 25</th> </tr> </thead> <tbody> <tr><td>210 10 bar g (145 psi g)</td><td>x</td><td>x</td></tr> <tr><td>211 11 bar g (160 psi g)</td><td>x</td><td>x</td></tr> <tr><td>212 12 bar g (174 psi g)</td><td>x</td><td>x</td></tr> <tr><td>213 13 bar g (188 psi g)</td><td>x</td><td>x</td></tr> <tr><td>214 14 bar g (203 psi g)</td><td>x</td><td>x</td></tr> <tr><td>215 15 bar g (218 psi g)</td><td>x</td><td>x</td></tr> <tr><td>216 16 bar g (232 psi g)</td><td>x</td><td>x</td></tr> <tr><td>217 17 bar g (247 psi g)</td><td>x</td><td>x</td></tr> <tr><td>218 18 bar g (261 psi g)</td><td>x</td><td>x</td></tr> <tr><td>219 19 bar g (276 psi g)</td><td>x</td><td>x</td></tr> <tr><td>220 20 bar g (290 psi g)</td><td>x</td><td>x</td></tr> <tr><td>221 21 bar g (305 psi g)</td><td>x</td><td>x</td></tr> <tr><td>222 22 bar g (319 psi g)</td><td>x</td><td>x</td></tr> <tr><td>223 23 bar g (334 psi g)</td><td>x</td><td>x</td></tr> <tr><td>224 24 bar g (348 psi g)</td><td>x</td><td>x</td></tr> <tr><td>225 25 bar g (363 psi g)</td><td>x</td><td>x</td></tr> </tbody> </table> <i>Standard pressure setting with TÜV certificate: 3××</i> <table border="1"> <thead> <tr> <th></th> <th>SFV 20</th> <th>SFV 25</th> </tr> </thead> <tbody> <tr><td>310 10 bar g (145 psi g)</td><td>x</td><td>x</td></tr> <tr><td>311 11 bar g (160 psi g)</td><td>x</td><td>x</td></tr> <tr><td>312 12 bar g (174 psi g)</td><td>x</td><td>x</td></tr> <tr><td>313 13 bar g (188 psi g)</td><td>x</td><td>x</td></tr> <tr><td>314 14 bar g (203 psi g)</td><td>x</td><td>x</td></tr> <tr><td>315 15 bar g (218 psi g)</td><td>x</td><td>x</td></tr> <tr><td>316 16 bar g (232 psi g)</td><td>x</td><td>x</td></tr> <tr><td>317 17 bar g (247 psi g)</td><td>x</td><td>x</td></tr> <tr><td>318 18 bar g (261 psi g)</td><td>x</td><td>x</td></tr> <tr><td>319 19 bar g (276 psi g)</td><td>x</td><td>x</td></tr> <tr><td>320 20 bar g (290 psi g)</td><td>x</td><td>x</td></tr> <tr><td>321 21 bar g (304 psi g)</td><td>x</td><td>x</td></tr> <tr><td>322 22 bar g (319 psi g)</td><td>x</td><td>x</td></tr> <tr><td>323 23 bar g (334 psi g)</td><td>x</td><td>x</td></tr> <tr><td>324 24 bar g (348 psi g)</td><td>x</td><td>x</td></tr> <tr><td>325 25 bar g (362 psi g)</td><td>x</td><td>x</td></tr> </tbody> </table>			SFV 20	SFV 25	210 10 bar g (145 psi g)	x	x	211 11 bar g (160 psi g)	x	x	212 12 bar g (174 psi g)	x	x	213 13 bar g (188 psi g)	x	x	214 14 bar g (203 psi g)	x	x	215 15 bar g (218 psi g)	x	x	216 16 bar g (232 psi g)	x	x	217 17 bar g (247 psi g)	x	x	218 18 bar g (261 psi g)	x	x	219 19 bar g (276 psi g)	x	x	220 20 bar g (290 psi g)	x	x	221 21 bar g (305 psi g)	x	x	222 22 bar g (319 psi g)	x	x	223 23 bar g (334 psi g)	x	x	224 24 bar g (348 psi g)	x	x	225 25 bar g (363 psi g)	x	x		SFV 20	SFV 25	310 10 bar g (145 psi g)	x	x	311 11 bar g (160 psi g)	x	x	312 12 bar g (174 psi g)	x	x	313 13 bar g (188 psi g)	x	x	314 14 bar g (203 psi g)	x	x	315 15 bar g (218 psi g)	x	x	316 16 bar g (232 psi g)	x	x	317 17 bar g (247 psi g)	x	x	318 18 bar g (261 psi g)	x	x	319 19 bar g (276 psi g)	x	x	320 20 bar g (290 psi g)	x	x	321 21 bar g (304 psi g)	x	x	322 22 bar g (319 psi g)	x	x	323 23 bar g (334 psi g)	x	x	324 24 bar g (348 psi g)	x	x	325 25 bar g (362 psi g)	x	x
	SFV 20	SFV 25																																																																																																							
210 10 bar g (145 psi g)	x	x																																																																																																							
211 11 bar g (160 psi g)	x	x																																																																																																							
212 12 bar g (174 psi g)	x	x																																																																																																							
213 13 bar g (188 psi g)	x	x																																																																																																							
214 14 bar g (203 psi g)	x	x																																																																																																							
215 15 bar g (218 psi g)	x	x																																																																																																							
216 16 bar g (232 psi g)	x	x																																																																																																							
217 17 bar g (247 psi g)	x	x																																																																																																							
218 18 bar g (261 psi g)	x	x																																																																																																							
219 19 bar g (276 psi g)	x	x																																																																																																							
220 20 bar g (290 psi g)	x	x																																																																																																							
221 21 bar g (305 psi g)	x	x																																																																																																							
222 22 bar g (319 psi g)	x	x																																																																																																							
223 23 bar g (334 psi g)	x	x																																																																																																							
224 24 bar g (348 psi g)	x	x																																																																																																							
225 25 bar g (363 psi g)	x	x																																																																																																							
	SFV 20	SFV 25																																																																																																							
310 10 bar g (145 psi g)	x	x																																																																																																							
311 11 bar g (160 psi g)	x	x																																																																																																							
312 12 bar g (174 psi g)	x	x																																																																																																							
313 13 bar g (188 psi g)	x	x																																																																																																							
314 14 bar g (203 psi g)	x	x																																																																																																							
315 15 bar g (218 psi g)	x	x																																																																																																							
316 16 bar g (232 psi g)	x	x																																																																																																							
317 17 bar g (247 psi g)	x	x																																																																																																							
318 18 bar g (261 psi g)	x	x																																																																																																							
319 19 bar g (276 psi g)	x	x																																																																																																							
320 20 bar g (290 psi g)	x	x																																																																																																							
321 21 bar g (304 psi g)	x	x																																																																																																							
322 22 bar g (319 psi g)	x	x																																																																																																							
323 23 bar g (334 psi g)	x	x																																																																																																							
324 24 bar g (348 psi g)	x	x																																																																																																							
325 25 bar g (362 psi g)	x	x																																																																																																							

Important!

Where products need to be certified according to specific certification societies, the relevant information should be included at the time of order.

Ordering
(cont.)

Certified SFV valves with standard set pressure

Size		Construction and test facilities are approved by TÜV		
mm	in.	Type	Bar g (psi g)	Part no.
20	3/4	SFV20 T 210	10 (145)	2416+254
20	3/4	SFV20 T 211	11 (160)	2416+255
20	3/4	SFV20 T 212	12 (174)	2416+256
20	3/4	SFV20 T 213	13 (189)	2416+150
20	3/4	SFV20 T 214	14 (203)	2416+257
20	3/4	SFV20 T 215	15 (218)	2416+258
20	3/4	SFV20 T 216	16 (232)	2416+259
20	3/4	SFV20 T 217	17 (247)	2416+260
20	3/4	SFV20 T 218	18 (261)	2416+151
20	3/4	SFV20 T 219	19 (276)	2416+261
20	3/4	SFV20 T 220	20 (290)	2416+262
20	3/4	SFV20 T 221	21 (305)	2416+152
20	3/4	SFV20 T 222	22 (319)	2416+241
20	3/4	SFV20 T 223	23 (334)	2416+263
20	3/4	SFV20 T 224	24 (348)	2416+264
20	3/4	SFV20 T 225	25 (363)	2416+183

Certified SFV valves with standard set pressure and TÜV pressure setting certificate with each valve

Size		Each valve is certified by a representative from TÜV		
mm	in.	Type	Bar g (psi g)	Part no.
20	3/4	SFV20 T 310	10 (145)	2416+285
20	3/4	SFV20 T 311	11 (160)	2416+286
20	3/4	SFV20 T 312	12 (174)	2416+287
20	3/4	SFV20 T 313	13 (189)	2416+160
20	3/4	SFV20 T 314	14 (203)	2416+288
20	3/4	SFV20 T 315	15 (218)	2416+289
20	3/4	SFV20 T 316	16 (232)	2416+290
20	3/4	SFV20 T 317	17 (247)	2416+291
20	3/4	SFV20 T 318	18 (261)	2416+161
20	3/4	SFV20 T 319	19 (276)	2416+292
20	3/4	SFV20 T 320	20 (290)	2416+293
20	3/4	SFV20 T 321	21 (305)	2416+162
20	3/4	SFV20 T 322	22 (319)	2416+294
20	3/4	SFV20 T 323	23 (334)	2416+295
20	3/4	SFV20 T 324	24 (348)	2416+296
20	3/4	SFV20 T 325	25 (363)	2416+186

Certified SFV valves with standard set pressure

Size		Construction and test facilities are approved by TÜV		
mm	in.	Type	Bar g (psi g)	Part no.
25	1	SFV25 T 210	10 (145)	2416+265
25	1	SFV25 T 211	11 (160)	2416+266
25	1	SFV25 T 212	12 (174)	2416+267
25	1	SFV25 T 213	13 (189)	2416+153
25	1	SFV25 T 214	14 (203)	2416+268
25	1	SFV25 T 215	15 (218)	2416+269
25	1	SFV25 T 216	16 (232)	2416+270
25	1	SFV25 T 217	17 (247)	2416+271
25	1	SFV25 T 218	18 (261)	2416+154
25	1	SFV25 T 219	19 (276)	2416+272
25	1	SFV25 T 220	20 (290)	2416+273
25	1	SFV25 T 221	21 (305)	2416+155
25	1	SFV25 T 222	22 (319)	2416+242
25	1	SFV25 T 223	23 (334)	2416+274
25	1	SFV25 T 224	24 (348)	2416+275
25	1	SFV25 T 225	25 (363)	2416+184

Certified SFV valves with standard set pressure and TÜV pressure setting certificate with each valve

Size		Each valve is certified by a representative from TÜV		
mm	in.	Type	Bar g (psi g)	Part no.
25	1	SFV25 T 310	10 (145)	2416+297
25	1	SFV25 T 311	11 (160)	2416+298
25	1	SFV25 T 312	12 (174)	2416+299
25	1	SFV25 T 313	13 (189)	2416+163
25	1	SFV25 T 314	14 (203)	2416+300
25	1	SFV25 T 315	15 (218)	2416+301
25	1	SFV25 T 316	16 (232)	2416+302
25	1	SFV25 T 317	17 (247)	2416+303
25	1	SFV25 T 318	18 (261)	2416+164
25	1	SFV25 T 319	19 (276)	2416+304
25	1	SFV25 T 320	20 (290)	2416+305
25	1	SFV25 T 321	21 (305)	2416+165
25	1	SFV25 T 322	22 (319)	2416+306
25	1	SFV25 T 323	23 (334)	2416+307
25	1	SFV25 T 324	24 (348)	2416+308
25	1	SFV25 T 325	25 (363)	2416+187

Flanges and gaskets

Type	Code No.
Flanges + gaskets set for SFV 20	148F3020
Flanges + gaskets set for SFV 25	148F3021

Repair kit

Type	Code No.
Repair kit for SFV 20 (gaskets and cone)	2453+082
Repair kit for SFV 25 (gaskets and cone)	2453+083